



Ledinaire floodlight

BVP155 LED100/840 PSU 100W AWB CE

LED module 10000 lm - 840 neutral white - Power supply unit - Asymmetrical

The Ledinaire range contains a selection of popular off-the-shelf LED luminaires that comes with the Philips high quality levels at a competitive price. Reliable, energy-efficient and affordable – just what you need.

Product data

General Information	
Lamp family code	LED100 [LED module 10000 lm]
Light source color	840 neutral white
Light source replaceable	No
Number of gear units	-
Driver/power unit/transformer	Power supply unit
Driver included	Yes
Optical cover/lens type	Clear glass
Luminaire light beam spread	30° x 80°
Control interface	-
Connection	Flying leads/wires
Cable	Cable 1.0 m without plug
Protection class IEC	Safety class I
Flammability mark	-
CE mark	CE mark
ENEC mark	-
Warranty period	3 years
Optic type outdoor	Asymmetrical
Constant light output	No
Number of products on MCB of 16 A type B	22

EU RoHS compliant	Yes
Light source engine type	LED
Light Technical	
Upward light output ratio	0
Standard tilt angle posttop	0°
Standard tilt angle side entry	0°
Operating and Electrical	
Input Voltage	220 to 240 V
Input Frequency	50 or 60 Hz
Initial CLO power consumption	- W
Average CLO power consumption	- W
End CLO power consumption	- W
Inrush current	2.48 A
Inrush time	0.019 ms
Power Factor (Min)	0.9

Ledinaire floodlight

Controls and Dimming

Dimmable	No
----------	----

Mechanical and Housing

Housing Material	Aluminum die cast
Reflector material	Polycarbonate
Optic material	Polycarbonate
Optical cover/lens material	Glass
Fixation material	Steel
Mounting device	Mounting bracket adjustable
Optical cover/lens shape	Flat
Optical cover/lens finish	Clear
Overall length	244 mm
Overall width	58 mm
Overall height	311 mm
Effective projected area	0.07 m ²
Color	Aluminum and gray
Dimensions (Height x Width x Depth)	311 x 58 x 244 mm (12.2 x 2.3 x 9.6 in)

Approval and Application

Ingress protection code	IP65 [Dust penetration-protected, jet-proof]
Mech. impact protection code	IK08 [5 J vandal-protected]
Surge Protection (Common/Differential)	Luminaire surge protection level until 4 kV differential mode and 4 kV common mode

Initial Performance (IEC Compliant)

Initial luminous flux (system flux)	10000 lm
Luminous flux tolerance	+/-10%

Initial LED luminaire efficacy	100 lm/W
Init. Corr. Color Temperature	4000 K
Init. Color Rendering Index	80
Initial chromaticity	<7 SDCM
Initial input power	100 W
Power consumption tolerance	+/-10%

Over Time Performance (IEC Compliant)

Control gear failure rate at median useful life	10 %
50000 h	
Lumen maintenance at median useful life*	L70
50000 h	

Application Conditions

Ambient temperature range	-25 to +40 °C
Maximum dim level	Not applicable

Product Data

Full product code	871016333128799
Order product name	BVP155 LED100/840 PSU 100W AWB CE
EAN/UPC - Product	8710163331287
Order code	911401733302
Numerator - Quantity Per Pack	1
Numerator - Packs per outer box	4
Material Nr. (12NC)	911401733302
Net Weight (Piece)	3.180 kg

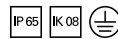

Dimensional drawing

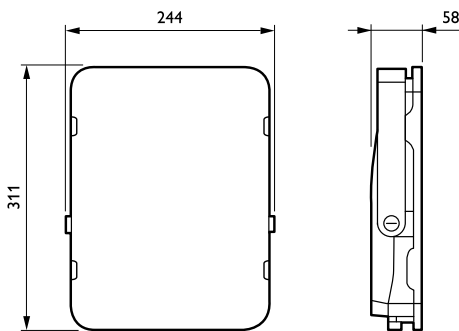

Ledinaire floodlight BVP105/106

Ledinaire floodlight

